

Электрические схемы

Разд.		Стр.
F.1	Электрическая схема	
F.2	Запасные части	
	Плата питания	
	Панель управления	

код

RT-5402-EL

модель

РОТАЦИОННАЯ

питание

ЭЛЕКТРИЧЕСКАЯ

управление

LCD

details

С АВТОМАТИЧЕСКИМ КЛАПАНОМ
ОДНОФАЗНАЯ ВЫТЯЖКА
С ДАТЧИКОМ ОТКРЫВАНИЯ ДВЕРИ
С КРЮКОМ ИЛИ ПЛАТФОРМОЙ

Рабочее напряжение

230-400 Vac

Вспомогательное
напряжение

24 Vac

частота

50-60 Hz

CE

редакция

R-0

Дата производства

01/09/2016

дата
редакции

01/09/2016

разработка

DF

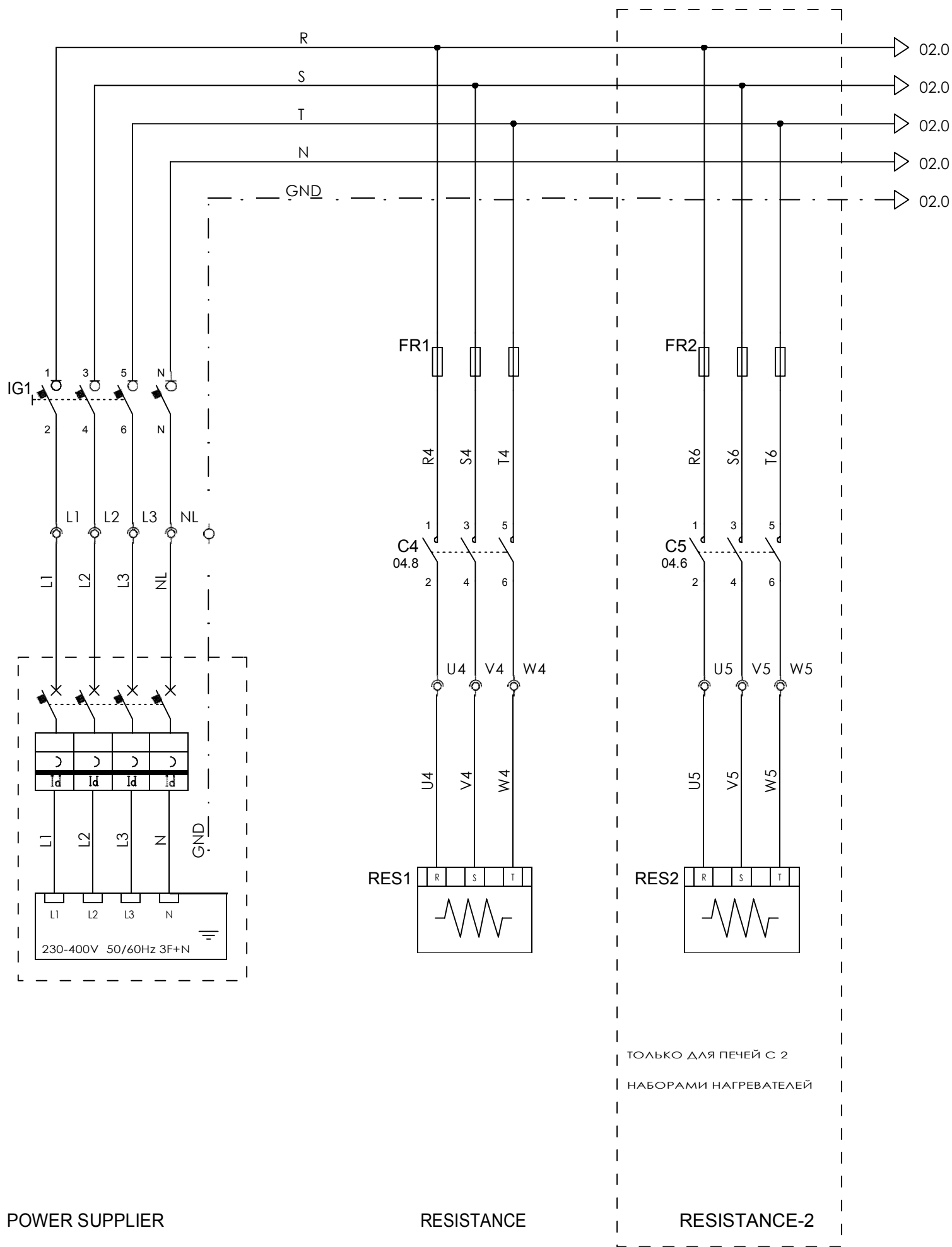

POWER SUPPLIER

RESISTANCE

RESISTANCE-2

ТОЛЬКО ДЛЯ ПЕЧЕЙ С 2
НАБОРАМИ НАГРЕВАТЕЛЕЙ

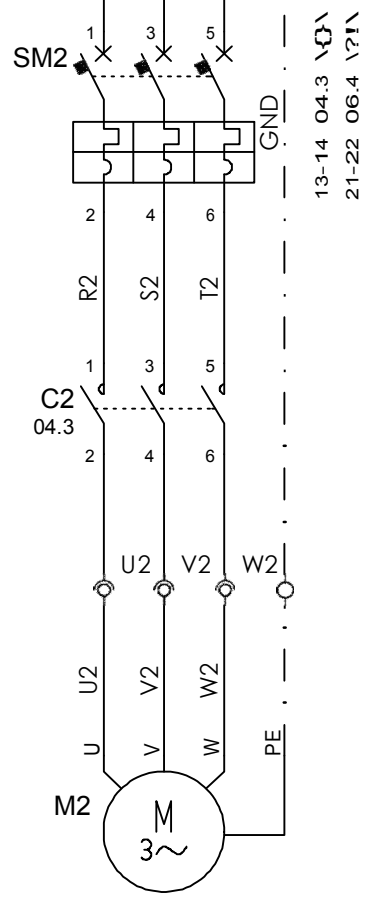
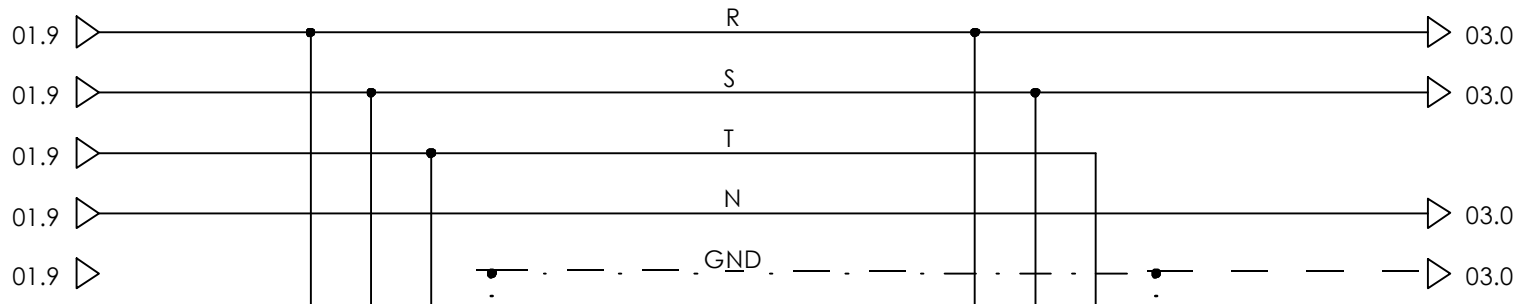

BLOWER

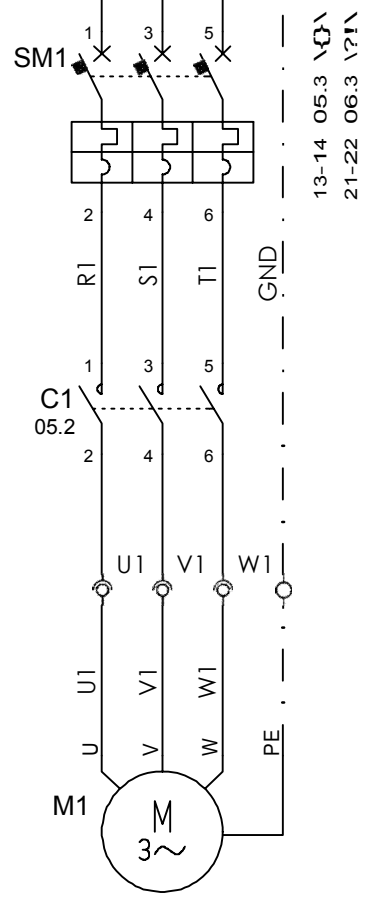

RACK

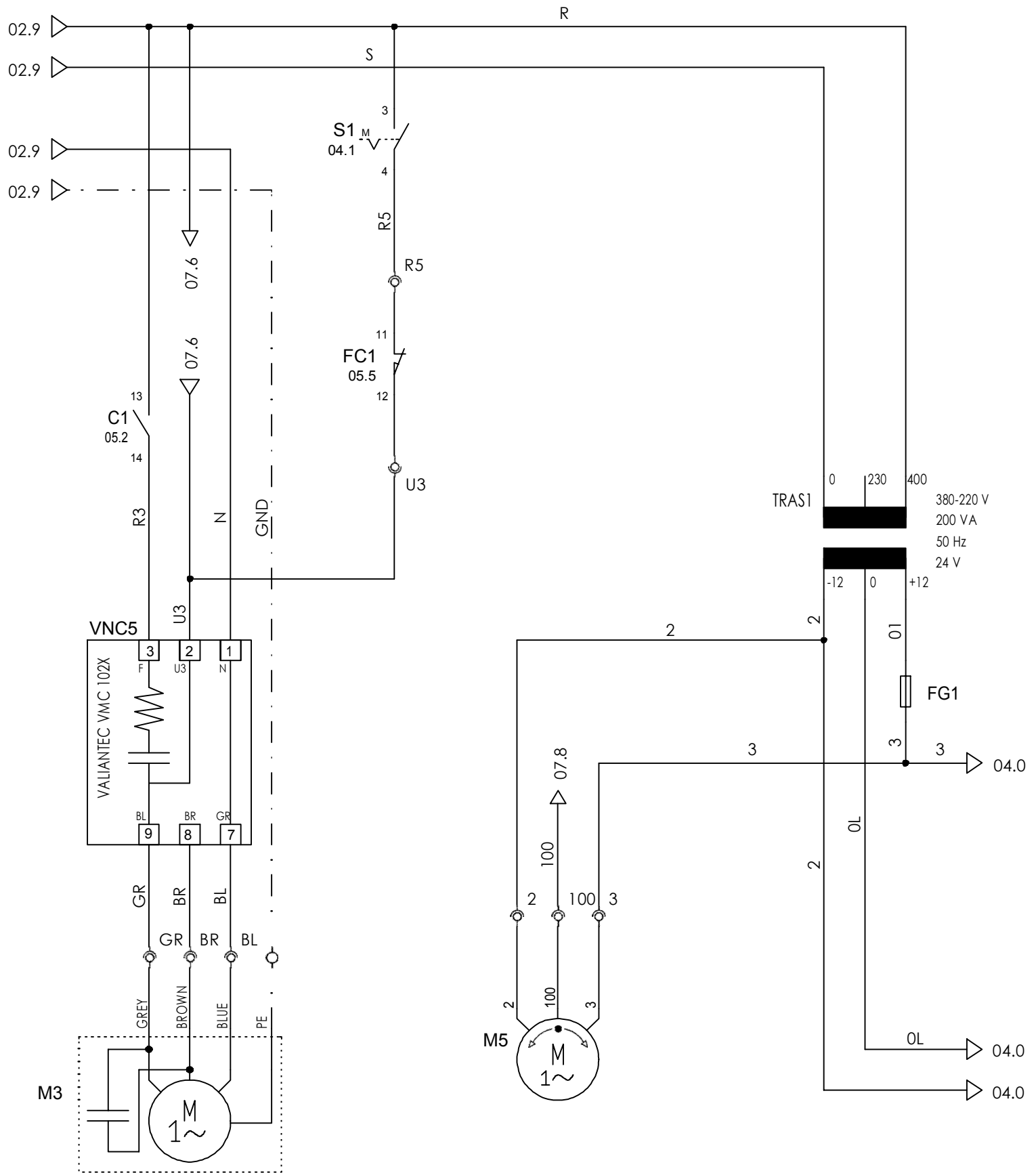

STEAM SUCTION FAN

STEAM EXHAUST VALVE

TRANSFORMER

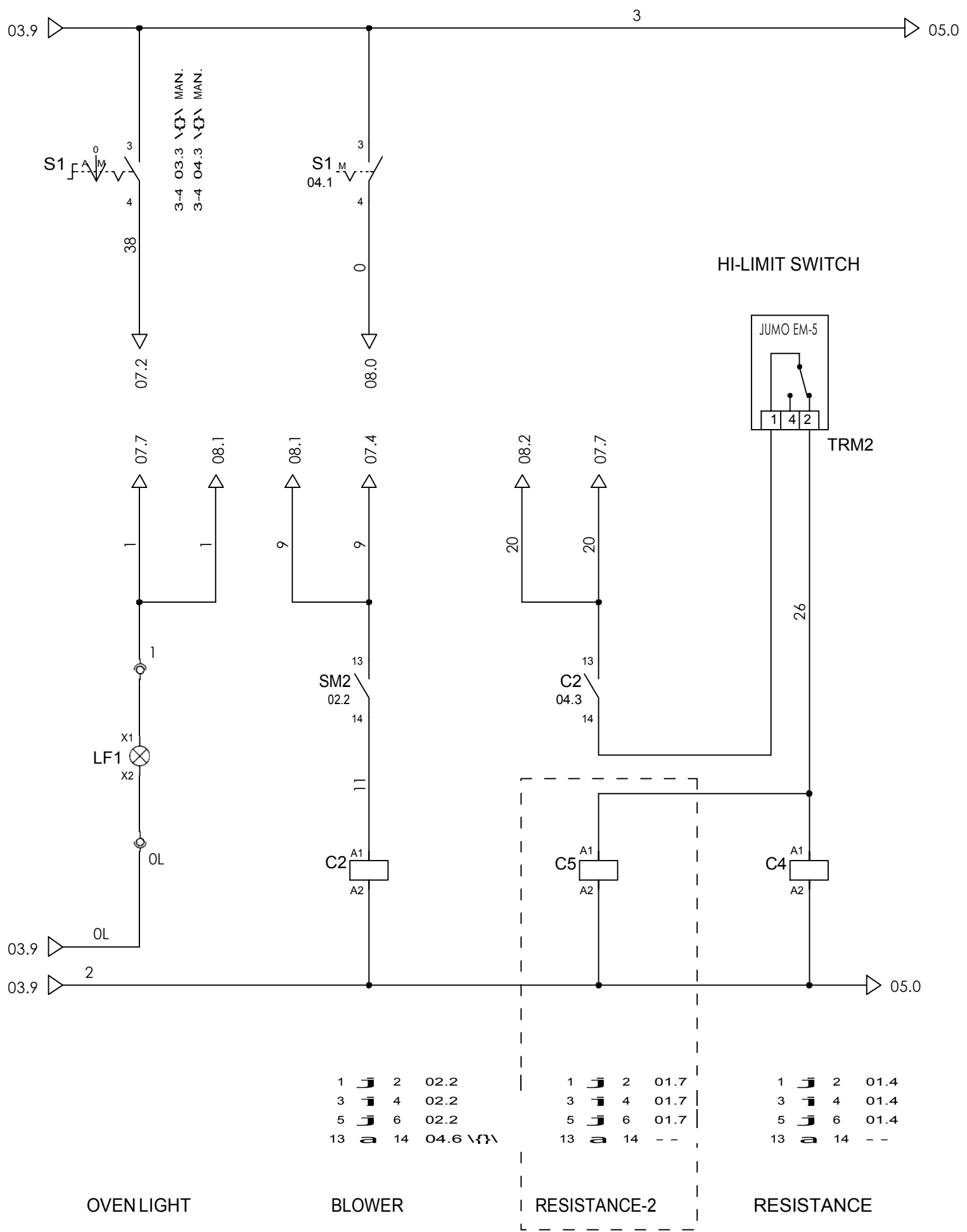

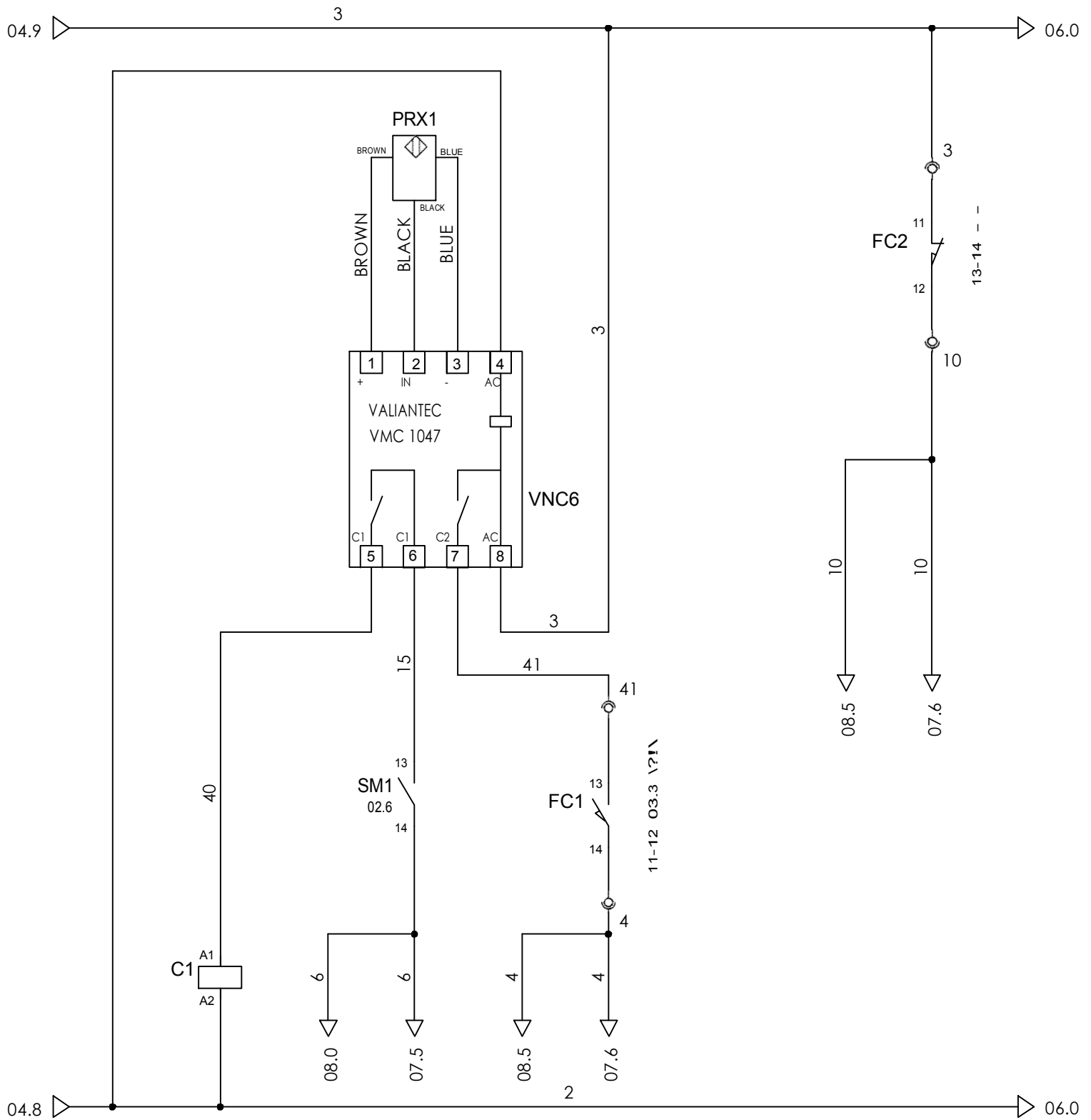

- | | | | |
|----|--|----|------|
| 1 | | 2 | 02.6 |
| 3 | | 4 | 02.6 |
| 5 | | 6 | 02.6 |
| 13 | | 14 | 03.1 |

RACK ROTATION

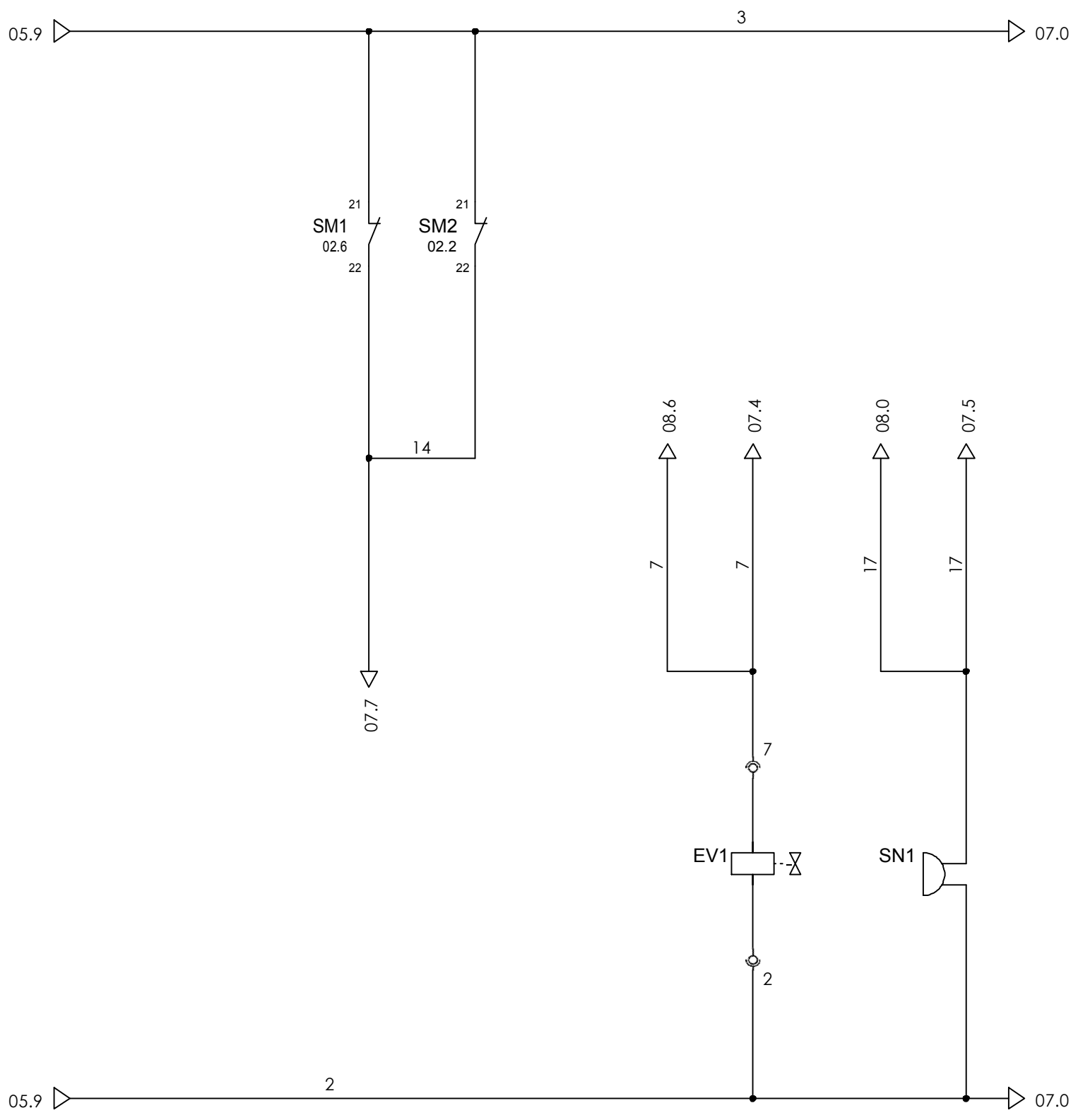

STEAM SOLENOID VALVE BUZZER

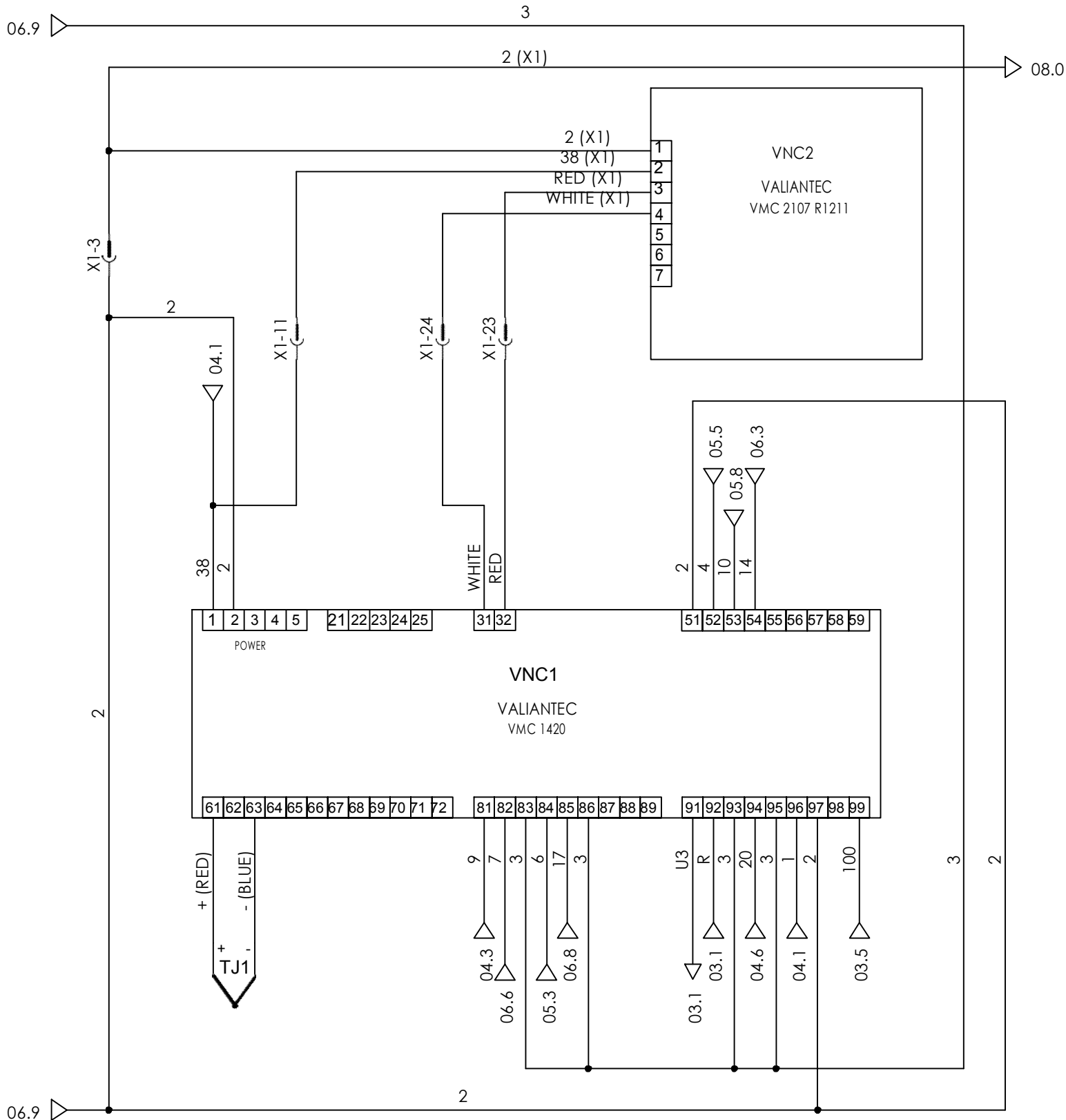

LCDBOARD POWER

LCD BOARD DISPLAY

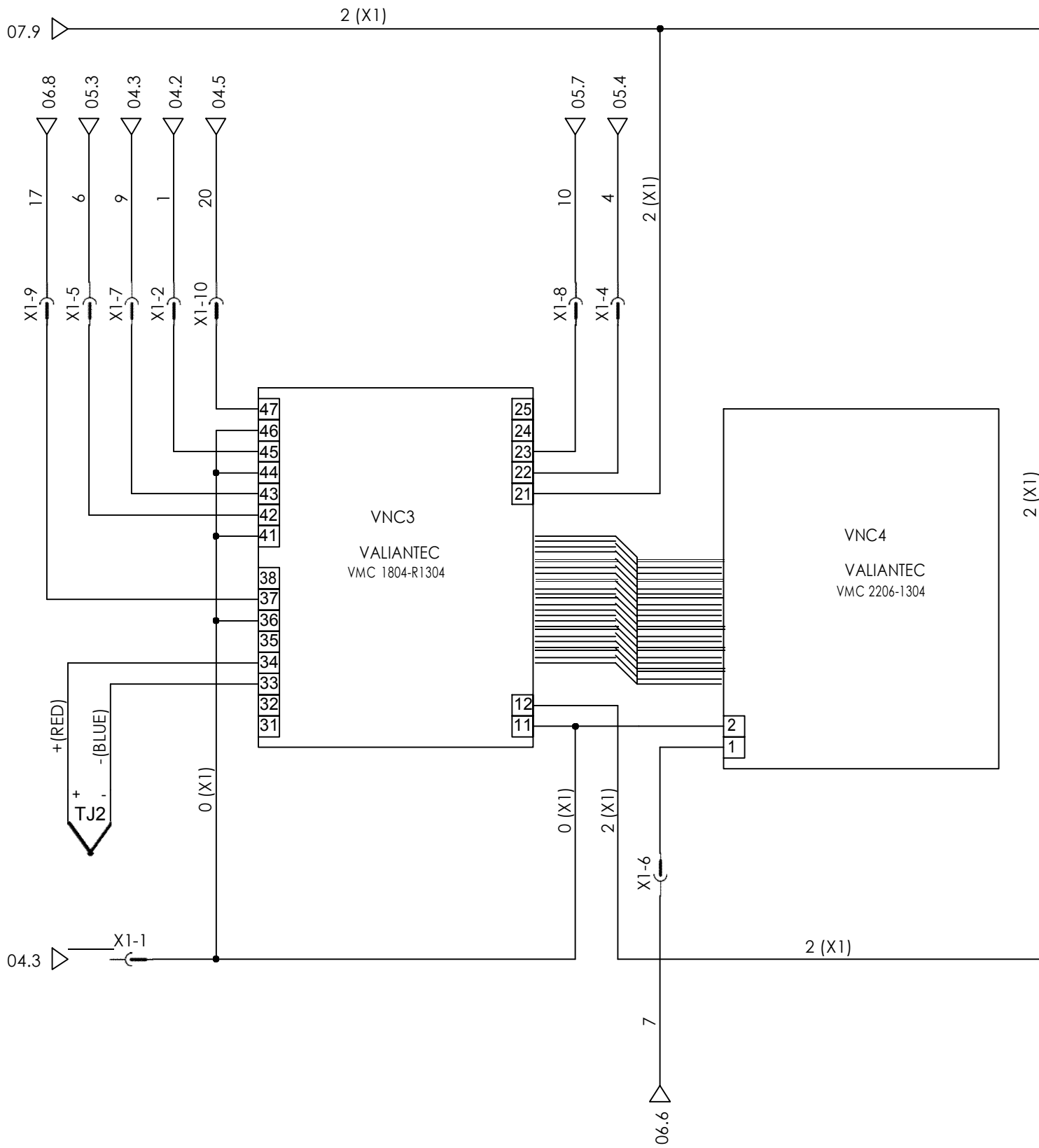

LCD BOARD POWER - MANUAL

LCD BOARD DISPLAY - MANUAL

CONNECTOR

X1

WIRE	TERMINALS	POSITION
------	-----------	----------

N° PIN : 24
PRODUCER : ILME

LIST LOCATIONS	
BM	ON UNIT
CP	POWER BOX
QC	CONTROL PANEL

COLUMN PAGE

0	1	1	08
1	2	1	08
2	3	1	07
4	4	5	08
6	5	0	08
7	6	6	08
9	7	1	08
10	8	5	08
17	9	0	08
20	10	2	08
38	11	2	07

12	RESERVE
13	RESERVE
14	RESERVE
15	RESERVE
16	RESERVE
17	RESERVE
18	RESERVE
19	RESERVE
20	RESERVE
21	RESERVE
22	RESERVE

RED	23	4	07
WHITE	24	4	07

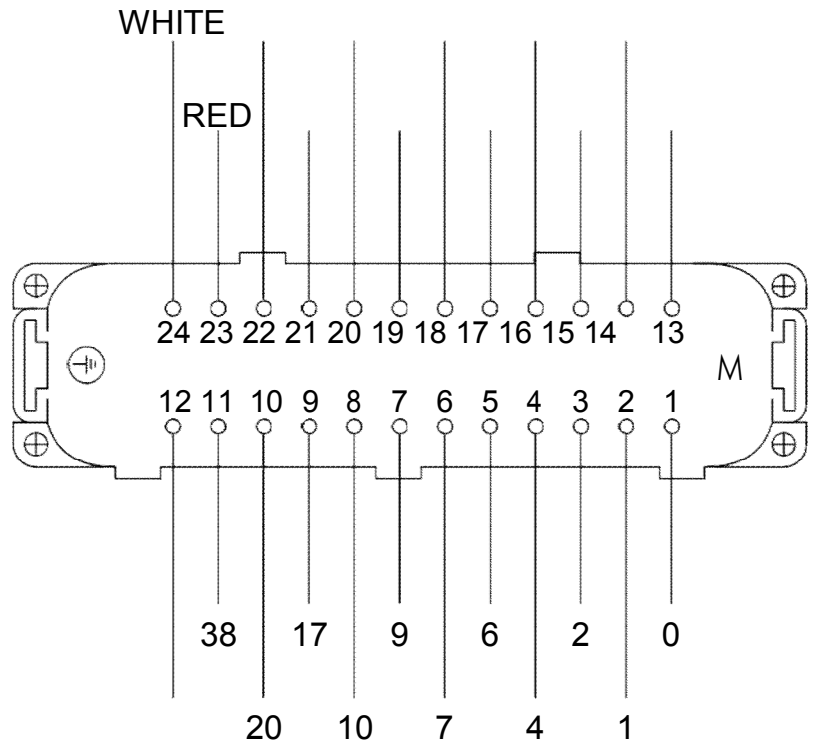

USAGE SUMMARY

Y1



POWER SUPPLIER

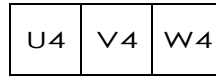

RESISTANCE



RESISTANCE-2

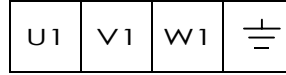

RACK ROTATION

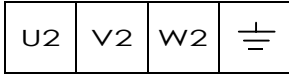

BLOWER MOTOR



STEAM SUCTION FAN MOTOR

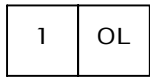

OVEN LIGHT

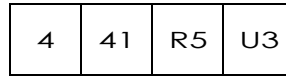

DOOR LIMIT SWITCH

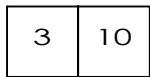

RACK LIMIT SWITCH

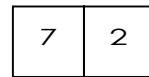

STEAM SOLENOID VALVE

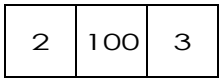

STEAM EXHAUST VALVE

PARTS LIST

code	DESCRIPTION	SPARE PART	LOCATION	PAGE
C1	RACK ROTATION MOTOR CONTACTOR	PRR 88	CP	05
C2	BLOWER MOTOR CONTACTOR	PRR 88	CP	04
C4	RESISTANCE CONTACTOR	PRR 87	CP	04
C5	RESISTANCE CONTACTOR-2	PRR 87	CP	04
EV1	STEAM SOLENOID VALVE	PRR 22	BM	06
FC1	DOOR LIMIT SWITCH	PRR 25	BM	05
FC2	RACK LIMIT SWITCH	PRR 25	BM	05
FG1	MAIN FUSE	PRR 27 - PRR 52/3	CP	03
FR1	RESISTANCE FUSES	PRR 29 - PRR 49/1	CP	01
FR2	RESISTANCE FUSES-2	PRR 29 - PRR 49/1	CP	01
IG1	MAIN SWITCH	PRR 31	CP	01
LF1	OVEN LIGHT	PRR 34/1	BM	04
M1	RACK ROTATION MOTOR	PRR 40	BM	02
M2	BLOWER MOTOR	PRR 38	BM	02
M3	STEAM SUCTION FAN MOTOR	PRR 3/6	BM	03
M5	STEAM EXHAUST VALVE	PRR 53/1	BM	03
PRX1	PROXIMITY	PRR 44/7	BM	05
RES1	RESISTANCE	PRR 5	BM	01
RES2	RESISTANCE-2	PRR 5	BM	01

PARTS LIST

code	DESCRIPTION	SPARE PART	LOCATION	PAGE
S1	MAIN SELECTOR	PRR 69	QC	04
SM1	AUTOMATIC SWITCH FOR RACK MOTOR	PRR 32	CP	02
SM2	AUTOMATIC SWITCH FOR FAN MOTOR	PRR 32	CP	02
SN1	BUZZER	PRR 75/1	CP	06
TJ1	TEMPERATURE PROBE	PRR 72	CP	07
TJ2	TEMPERATURE PROBE - MANUAL	PRR 72	QC	08
TRAS1	TRANSFORMER	PRR 86	CP	03
TRM2	HI-LIMIT SWITCH	PRR 78	CP	04
VNC1	LCD BOARD POWER	PRR 66/4	CP	07
VNC2	LCD BOARD DISPLAY	PRR 66/3	QC	07
VNC3	LCD BOARD POWER - MANUAL	PRR 66/5	QC	08
VNC4	LCD BOARD DISPLAY - MANUAL	PRR 66/5	QC	08
VNC5	MODULE - 2 SPEED	PRR 36/6	CP	03
VNC6	PROXIMITY RELAY	PRR 61/5	CP	05

0	1	2	3	4	5	6	7	8	9
---	---	---	---	---	---	---	---	---	---

Power board

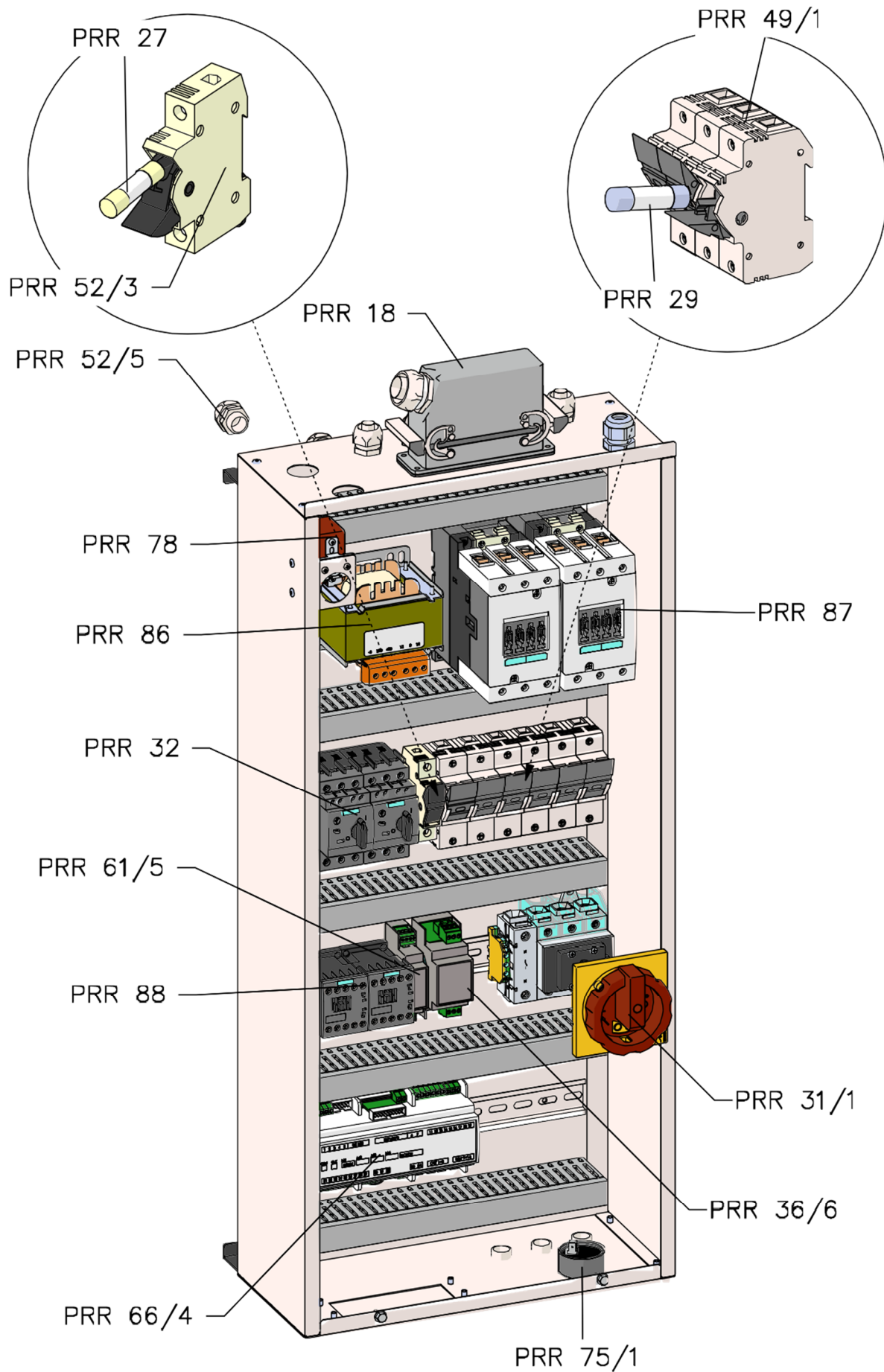

PRR 53/8

code

PRR 18	Electric board connector completed
PRR 29	Fuse for electric rotary ovens
PRR 31/1	Mains switch for electric rotary ovens
PRR 49/1	Fuse holder for electric rotary ovens (tripolar)
PRR 52/3	Standard fuse holder (single-polar)
PRR 52/5	Straight sheath through
PRR 52/7	Curved sheath through
PRR 61	Relay
PRR 75/1	Two-sound electronic beeper
PRR 78	Max temp. thermostat
PRR 86	200VA transformer
PRR 88	Normal remote-control switch
PRR 36/6	Interface For Steam Suction Fan - Single Phase
PRR 98	Base for relay
PRR 99	Base for Omron H3Y
PRR 61/5	Relay For Proximity
PRR 66/4	Power Card "LCD"
PRR 32	Automatic Switch
PRR 87	Remote-control switch for electric rotary ovens
PRR 27	Standard fuse

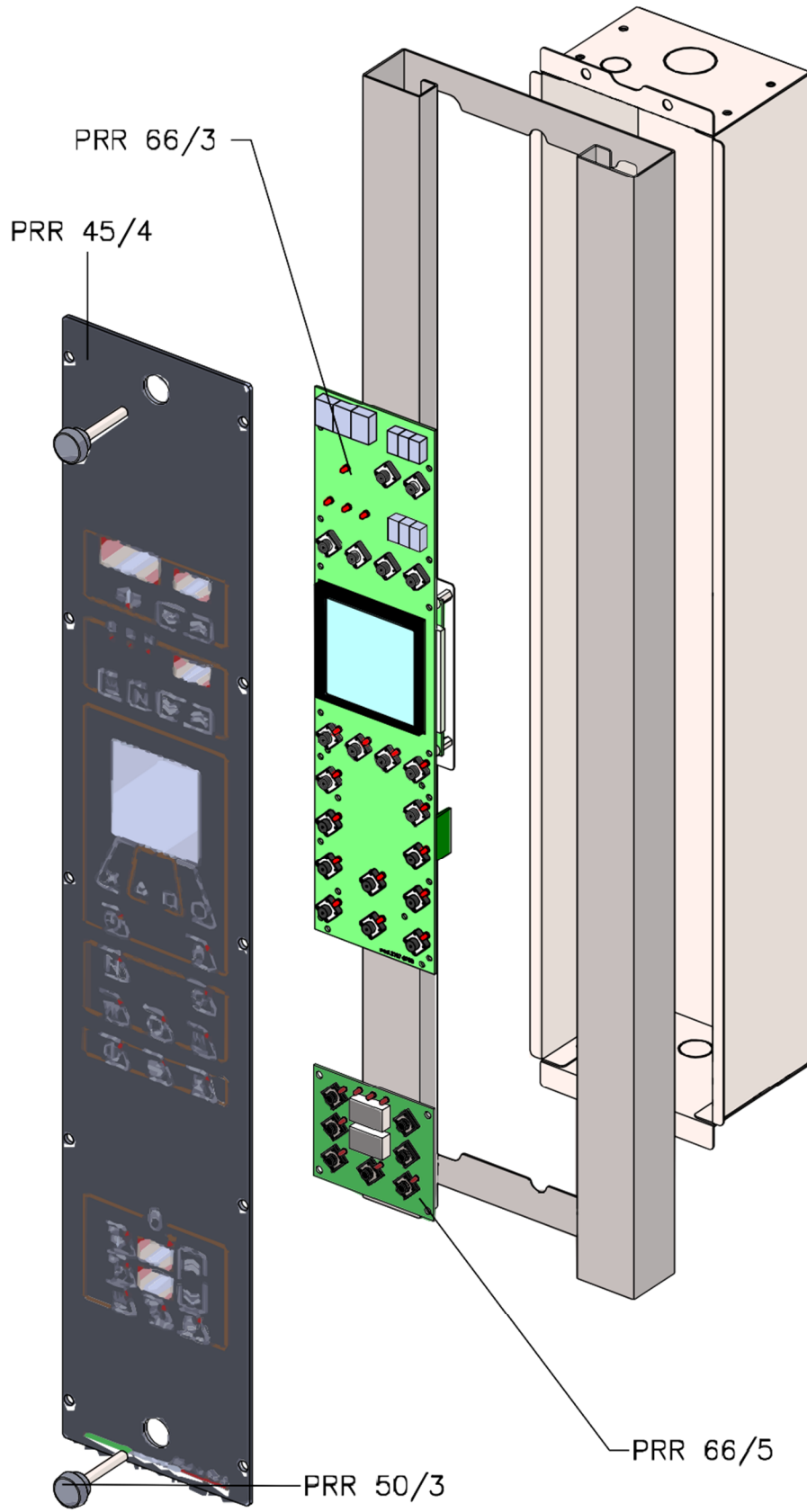

code

PRR 50/3	Screw With Black Knob
PRR 66/3	Display Card "LCD"
PRR 66/5	Emergency electronic board
PRR 45/4	"LCD" tool holder